

PRECISION 1.25 VOLT MICROPOWER VOLTAGE REFERENCE

ISSUE 2 - FEBRUARY 1997

ZRA125

DEVICE DESCRIPTION

The ZRA125 uses a bandgap circuit design to achieve a precision micropower voltage reference of 1.25 volts. The device is available in small outline surface mount packages, ideal for applications where space saving is important, as well as packages for through hole requirements.

The ZRA125 design provides a stable voltage without an external capacitor and is stable with capacitive loads. The ZRA125 is recommended for operation between $50\mu\text{A}$ and 5mA and so is ideally suited to low power and battery powered applications.

Excellent performance is maintained to a suggested absolute maximum of 25mA , however the rugged design and 20 volt processing allows the reference to withstand transient effects and currents up to 200mA . Superior switching capability allows the device to reach stable operating conditions in only a few microseconds.

FEATURES

- Small outline SOT23, SO8 and TO92 style packages
- No stabilising capacitor required

- Typical T_c $30\text{ppm}/^\circ\text{C}$
- Typical slope resistance 0.65Ω
- $\pm 3\%$, 2% and 1% tolerance
- Industrial temperature range
- Operating current $50\mu\text{A}$ to 5mA
- Transient response, stable in less than $10\mu\text{s}$
- Optional extended current range

APPLICATIONS

- Battery powered and portable equipment.
- Metering and measurement systems.
- Instrumentation.
- Data acquisition systems.
- Precision power supplies.
- Test equipment.

SCHEMATIC DIAGRAM

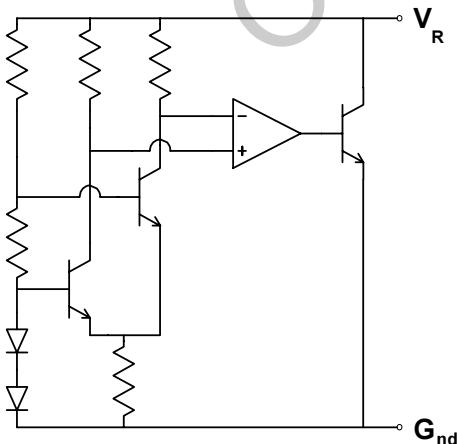

ZRA125

ABSOLUTE MAXIMUM RATING

Reverse Current	25mA
Forward Current	25mA
Operating Temperature	-40 to 85°C
Storage Temperature	-55 to 125°C

Power Dissipation (T_{amb}=25°C)

SOT23	330mW
E-Line, 3 pin (TO92)	500mW
E-Line, 2 pin (TO92)	500mW
SO8	625mW

ELECTRICAL CHARACTERISTICS

TEST CONDITIONS (Unless otherwise stated) T_{amb}=25°C

SYMBOL	PARAMETER	CONDITIONS	LIMITS			TOL. %	UNITS
			MIN	TYP	MAX		
V _R	Reverse Breakdown Voltage	I _R =150μA	1.228 1.225 1.21	1.24 1.25 1.25	1.252 1.275 1.29	1 2 3	V
I _{MIN}	Minimum Operating Current			30	50		μA
I _R	Recommended Operating Current		0.05		5		mA
T _C †	Average Reverse Breakdown Voltage Temp. Co.	I _R (min) to I _R (max)		30	90		ppm/°C
R _S §	Slope Resistance			0.65	2		Ω
Z _R	Reverse Dynamic Impedance	I _R = 1mA f = 100Hz I _{AC} = 0.1 I _R		0.5	1		Ω
E _N	Wideband Noise Voltage	I _R = 150μA f = 100Hz to 10kHz		40			μV(rms)

$$\dagger T_C = \frac{V_R \text{ Change} \times 1000000}{V_R \times \text{Temperature Change}}$$

$$\S R_S = \frac{V_R \text{ Change}(I_R(\text{min}) \text{ to } I_R(\text{max}))}{I_R(\text{max}) - I_R(\text{min})}$$

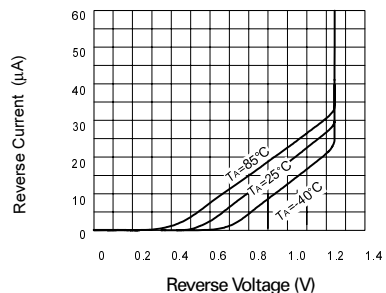

Reverse Characteristics

ZRA125

TYPICAL CHARACTERISTICS

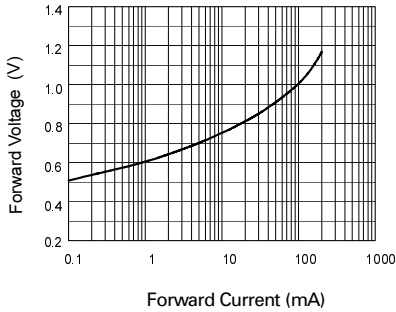

Forward Characteristics

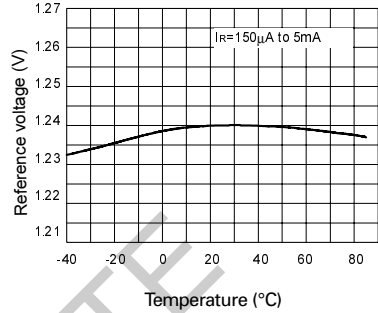

Temperature Drift

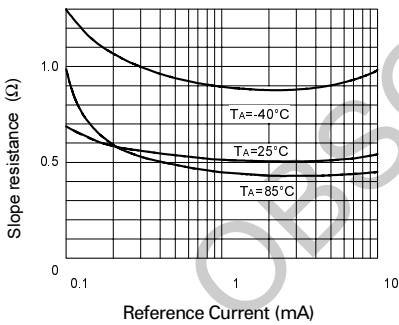

Slope Resistance v Current

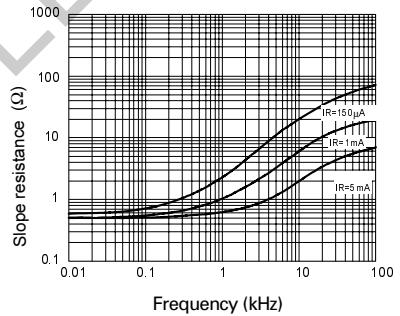

Slope Resistance v Frequency

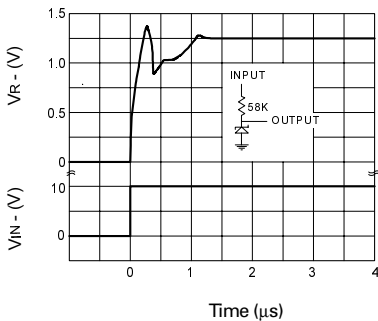

Transient Response ($I_R = 150\mu\text{A}$)

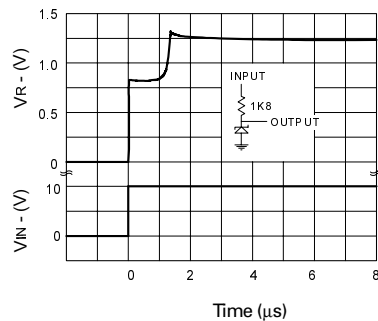

Transient Response ($I_R = 5\text{mA}$)

ZRA125

CONNECTION DIAGRAMS

E-Line, 2 pin Package Suffix – Y

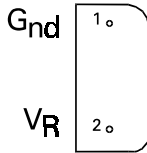

Bottom View

E-Line, 3 pin, Rev Package Suffix – R

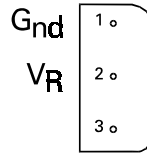

*Bottom View –
Pin 3 floating or connected to pin 1*

E-Line, 3 pin Package Suffix – A

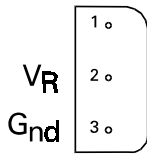

*Bottom View –
Pin 1 floating or connected to pin 3*

SO8 Package Suffix – N8

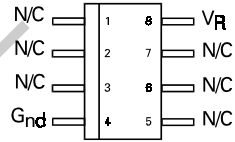

Top View

SOT23 Package Suffix – F

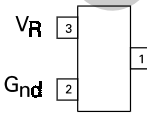

*Top View –
Pin 1 floating or connected to pin 2*

ZRA125

ORDERING INFORMATION

Part No	Tol%	Package	Partmark
ZRA125A03	3	E-Line •	ZRA12503
ZRA125A02	2	E-Line •	ZRA12502
ZRA125A01	1	E-Line •	ZRA12501
ZRA125F03	3	SOT23	12A
ZRA125F02	2	SOT23	12B
ZRA125F01	1	SOT23	12D
ZRA125N803	3	SO8	ZRA12503
ZRA125N802	2	SO8	ZRA12502
ZRA125N801	1	SO8	ZRA12501

Part No	Tol%	Package	Partmark
ZRA125R03	3	E-Line *	ZRA125R3
ZRA125R02	2	E-Line *	ZRA125R2
ZRA125R01	1	E-Line *	ZRA125R1
ZRA125Y03	3	E-Line †	ZRA12503
ZRA125Y02	2	E-Line †	ZRA12502
ZRA125Y01	1	E-Line †	ZRA12501

* E-Line 3 pin Reversed
† E-Line 2 pin
• E-Line 3 pin

OBSOLETE